

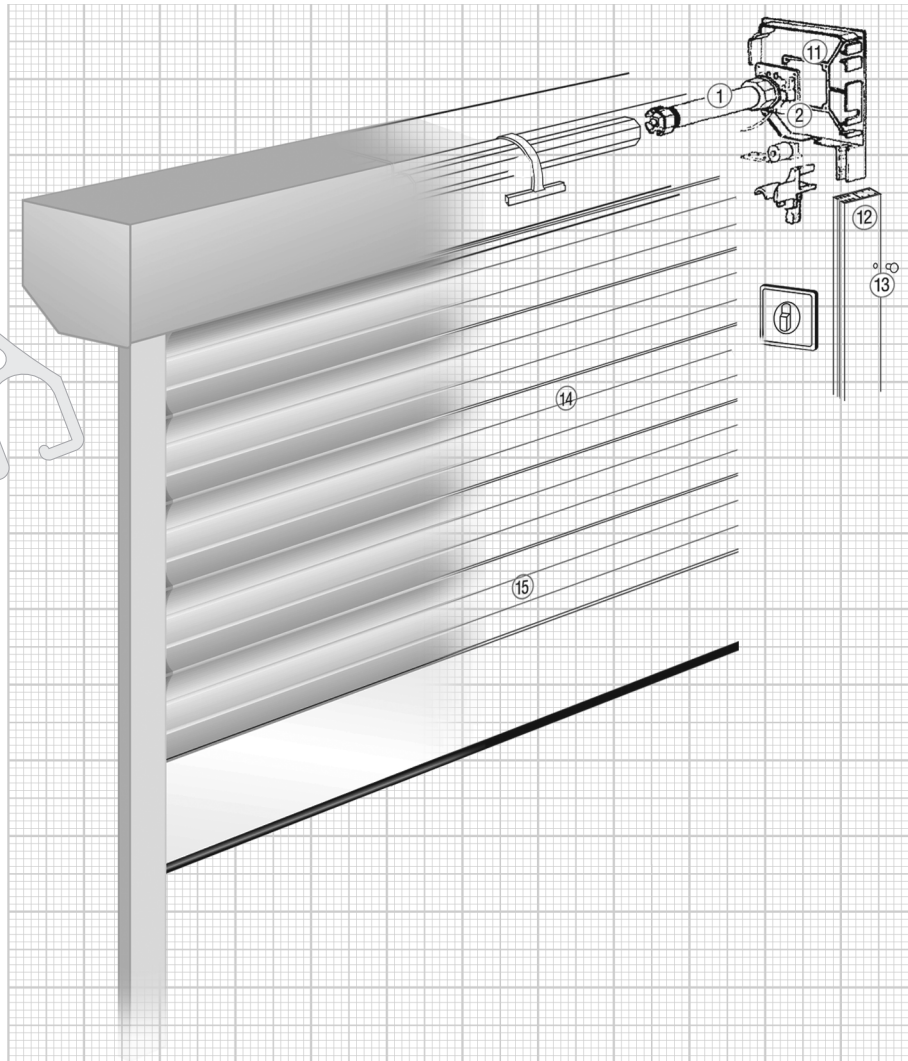

ALUSEL®

Yan Kapak İçi Plaketler

Brackets

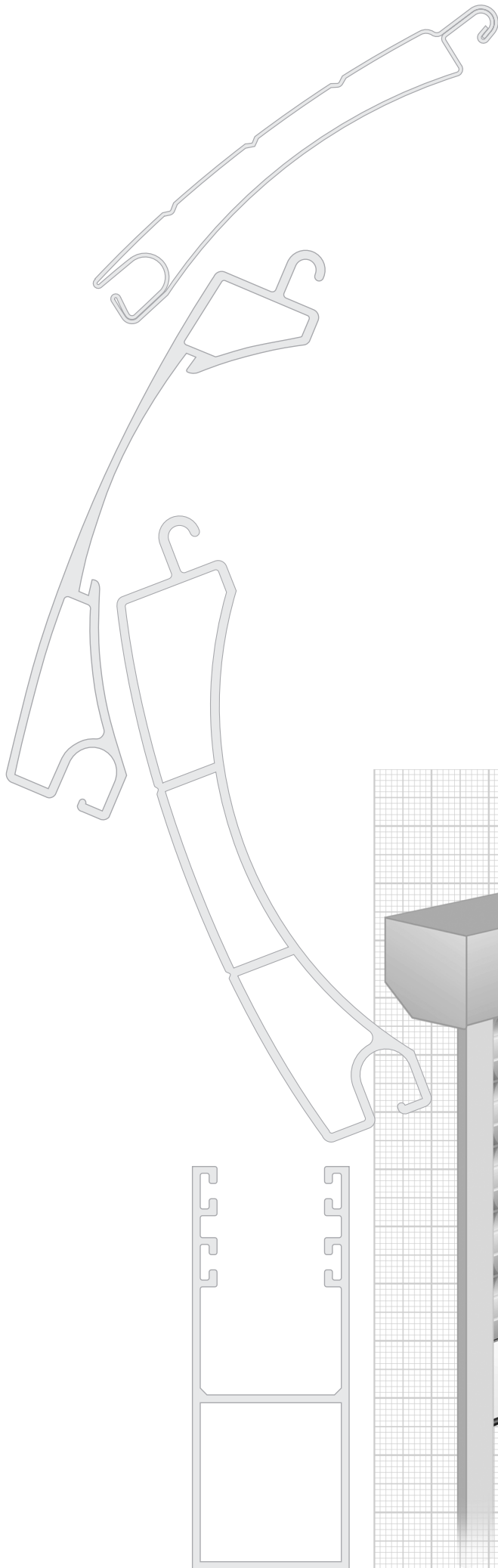

YAN KAPAK İÇİ PLAKETLER BRACKETS

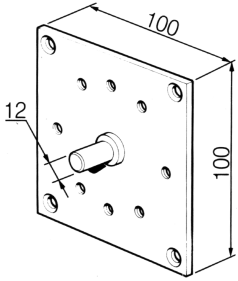
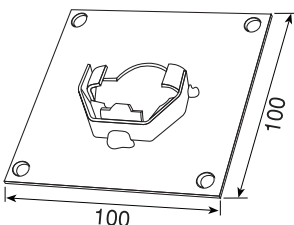
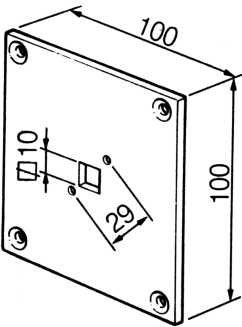
ÜRÜN ITEM	ÜRÜN ÖZELLİKLERİ PRODUCT DESCRIPTION	AMBALAJ PACKAGING	ÜRÜN KODU CODE
	<p>Galvanizli çelik pimli kare plaket <i>Galvanized steel square bracket with pivot</i></p> <p>Pimli 250-300 mm. alüminyum yan kapaklar ve tüm orta yataklar için. <i>With pivot for 250-300 mm. aluminium side frames and for all middle frames</i></p>	<p>100 Adet <i>100 Pieces</i></p>	<p>BR.100.00.PIV</p>
	<p>Galvanizli çelik 42 mm.lik rulman plaketi <i>Galvanized steel square bracket for 42 mm ball bearing</i></p> <p>250-300-350-400 mm.lik yan kapak uyumlu. <i>for 250-300-350-400 mm. end caps</i></p>	<p>100 Adet <i>100 Pieces</i></p>	<p>BR.100.00.ROB</p>
	<p>Galvanizli çelik tüp motor yatak plaketi <i>Galvanized steel square bracket for tubular motor</i></p>	<p>100 Adet <i>100 Pieces</i></p>	<p>BR.100.00.MOT</p>

YAN KAPAK İÇİ PLAKETLER BRACKETS

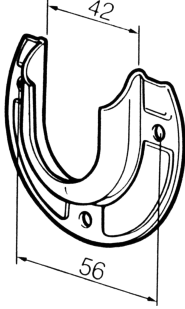
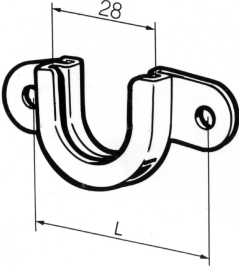
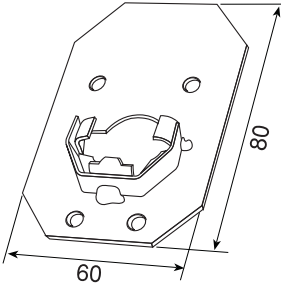
ÜRÜN İTEM	ÜRÜN ÖZELLİKLERİ PRODUCT DESCRIPTION	AMBALAJ PACKAGING	ÜRÜN KODU CODE
	Galvanizli çelik, 42 mm rulman kaseti <i>Galvanized steel, for ball bearing 42 mm</i>	100 Adet <i>100 Pieces</i>	BR.056.00.C42
	Galvanizli çelik, 28 mm rulman kaseti <i>Galvanized steel, for ball bearing 28 mm</i>	100 Adet <i>100 Pieces</i>	BR.042.00.C28
	Galvanizli çelik, 42 mm.lik rulman duvar plaketi <i>Galvanized steel, wall bracket for ball bearing 42 mm</i>	100 Adet <i>100 Pieces</i>	BR.060.00.C42

YAN KAPAK İÇİ PLAKETLER BRACKETS

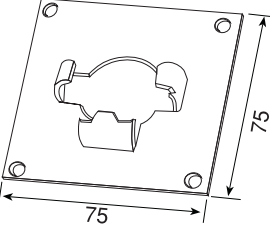
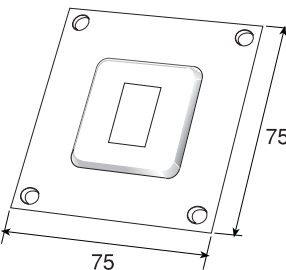
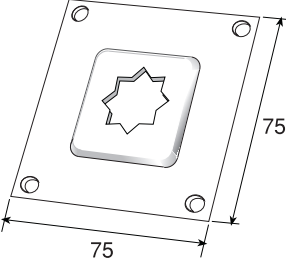
ÜRÜN ITEM	ÜRÜN ÖZELLİKLERİ PRODUCT DESCRIPTION	AMBALAJ PACKAGING	ÜRÜN KODU CODE
	<p>Galvanizli çelik, 75 mm. kare 42 mm rulman kaseti <i>Galvanized steel, 75 mm. square for ball bearing 42 mm</i></p> <p>137 mm-165 mm-180 mm-205 mm pimsiz yan kapaklar için <i>For 137 mm-165 mm-180 mm 205 mm side frames without pivot</i></p>	<p>100 Adet <i>100 Pieces</i></p>	BR.075.00.ROB
	<p>Galvanizli çelik, 75 mm. kare yan kapak tüp motor yatağı <i>Galvanized steel, 75 mm. square side frames bracket for tubular motors</i></p> <p>137 mm-165 mm-180 mm-205 mm pimsiz yan kapaklar için Elero 9 serisi, Mosel SEL-60 TYP serisi uyumlu <i>For 137 mm-165 mm-180 mm 205 mm side frames without pivot and elero 9 series, Mosel SEL-60 TYP series.</i></p>	<p>100 Adet <i>100 Pieces</i></p>	BR.075.60.MOT
	<p>Galvanizli çelik, 75 mm. kare yan kapak tüp motor yatağı <i>Galvanized steel, 75 mm. square side frames bracket for tubular motors</i></p> <p>137 mm-165 mm-180 mm-205 mm pimsiz yan kapaklar için Elero 11 serisi, Mosel SEL-70 TYP serisi uyumlu. <i>For 137 mm-165 mm-180 mm 205 mm side frames without pivot and elero 11 series, Mosel SEL-70 TYP series.</i></p>	<p>100 Adet <i>100 Pieces</i></p>	BR.075.70.MOT