

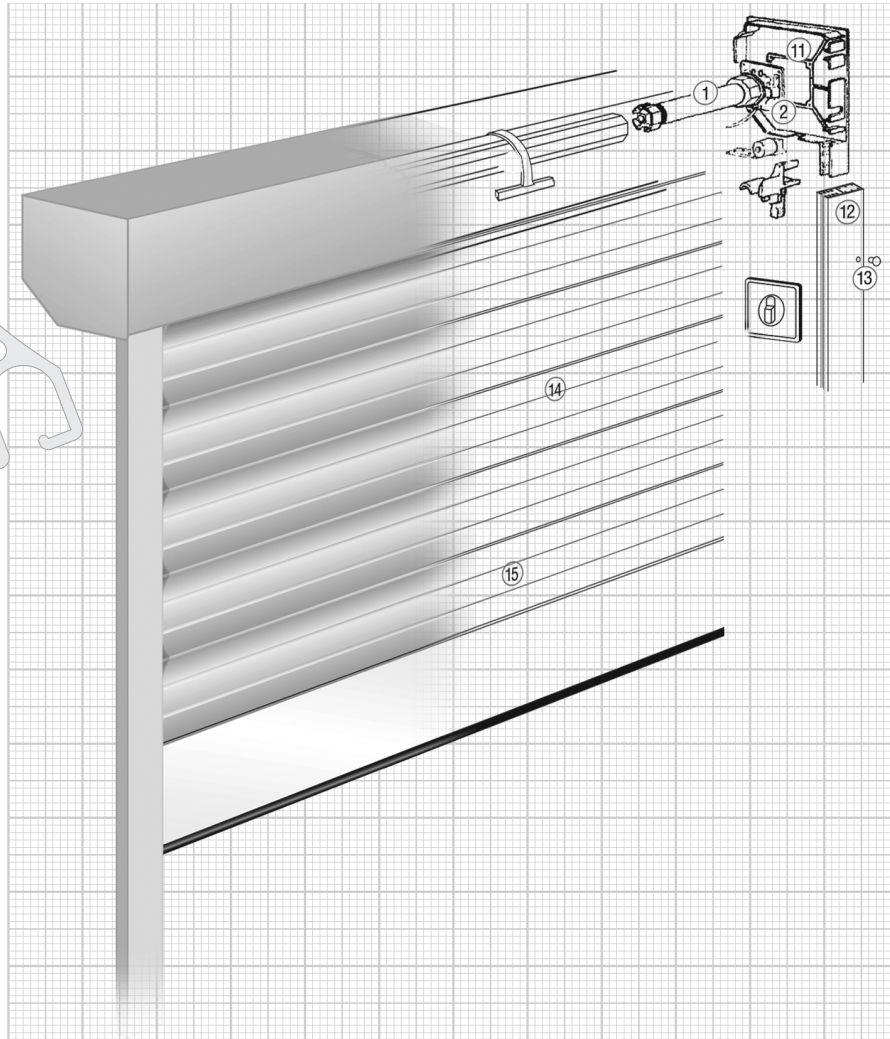

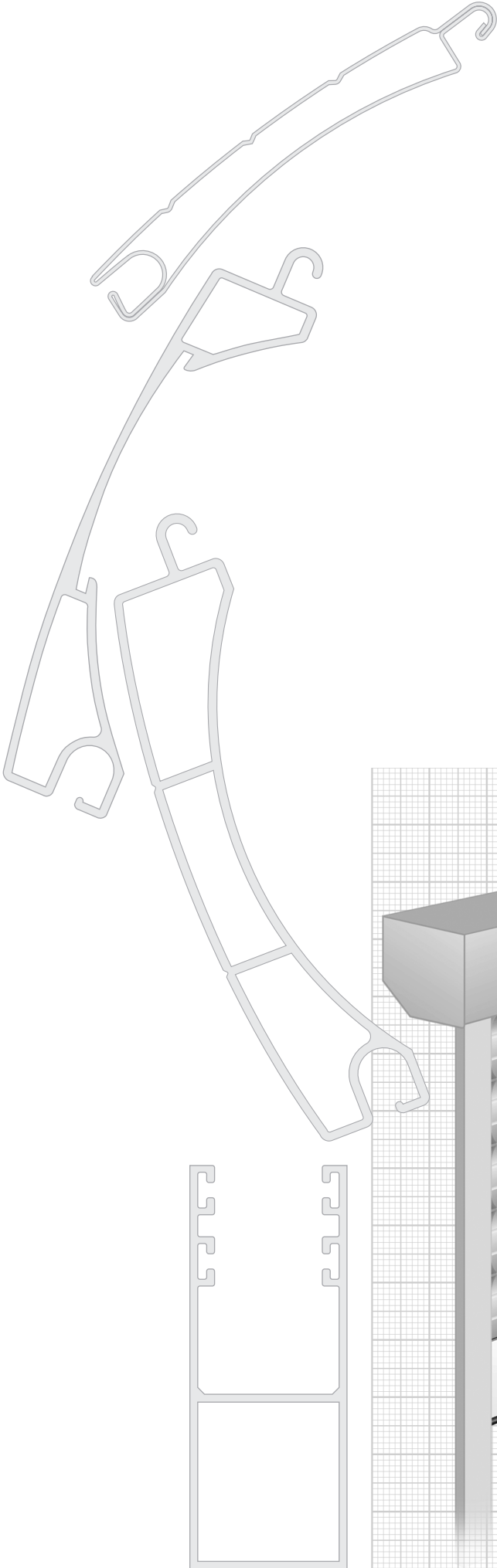

ALUSEL®

Alt Parçalar



End Slats

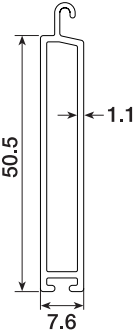

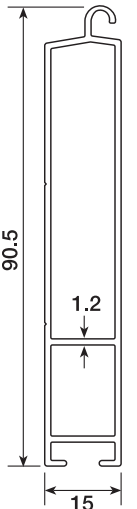
ALT PARÇALAR END SLATS

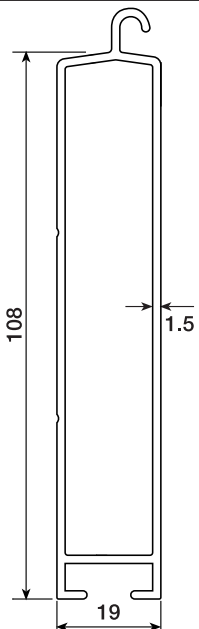
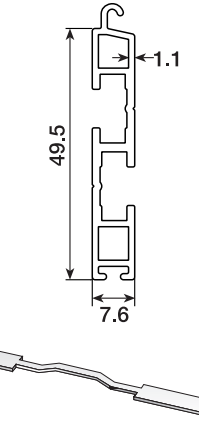
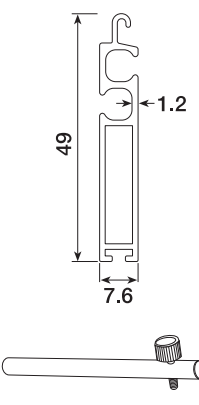
ÜRÜN İTEM	ÜRÜN ÖZELLİKLERİ PRODUCT DESCRIPTION	RENK COLOR	ÜRÜN KODU CODE
	<p>Alüminyum ekstrüzyon alt parça SL-39, SL-41, SL-45, SL-56 için <i>Aluminium extrusion end slat for SL-39, SL-41, SL-45, SL-56</i></p>	<p>Pres <i>Mill finish</i> Beyaz <i>White</i> Gri <i>Grey</i> Kahve <i>Brown</i> Metalik gri <i>Silver metallic</i> Krem <i>Ivory</i> Seçilen RAL <i>Selected RAL</i></p>	<p>ES.427.00.DAP ES.427.01.DAP ES.427.02.DAP ES.427.03.DAP ES.427.04.DAP ES.427.08.DAP ES.427.RA.DAP</p>
	AMBALAJ	standart boy 6.000 mm, 10 adetlik paketler halinde	
	PACKAGING	<i>bundles of 10 bars, standard length 6.000 mm</i>	
	<p>Alüminyum ekstrüzyon alt parça SL-55, ST-56, SE-60, SE-62, SE-63 için <i>Aluminium extrusion end slat for SL-55, ST-56, SE-60, SE-62, SE-63</i></p>	<p>Pres <i>Mill finish</i> Beyaz <i>White</i> Gri <i>Grey</i> Kahve <i>Brown</i> Metalik gri <i>Silver metallic</i> Krem <i>Ivory</i> Seçilen RAL <i>Selected RAL</i></p>	<p>ES.426.00.NAP ES.426.01.NAP ES.426.02.NAP ES.426.03.NAP ES.426.04.NAP ES.426.08.NAP ES.426.RA.NAP</p>
	AMBALAJ	standart boy 6.000 mm, 10 adetlik paketler halinde	
	PACKAGING	<i>bundles of 10 bars, standard length 6.000 mm</i>	
	<p>Alüminyum ekstrüzyon alt parça SL-75, SL-77, ST-77, SE-77, SE-78 için <i>Aluminium extrusion end slat for SL-75, SL-77, ST-77, SE-77, SE-78</i></p>	<p>Pres <i>Mill finish</i> Beyaz <i>White</i> Gri <i>Grey</i> Kahve <i>Brown</i> Metalik gri <i>Silver metallic</i> Krem <i>Ivory</i> Seçilen RAL <i>Selected RAL</i></p>	<p>ES.425.00.GAP ES.425.01.GAP ES.425.02.GAP ES.425.03.GAP ES.425.04.GAP ES.425.08.GAP ES.425.RA.GAP</p>
	AMBALAJ	standart boylar 4.000, 4.600, 5.200, 6.000, 6.500, 7.000 mm, 5 adetlik paketler halinde	
	PACKAGING	<i>bundles of 5 bars, standard lengths 4.000, 4.600, 5.200, 6.000, 6.500, 7.000 mm</i>	

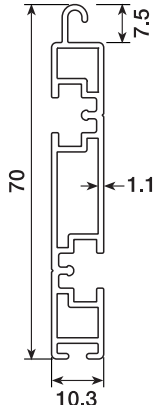
ÜRÜN İTEM	ÜRÜN ÖZELLİKLERİ PRODUCT DESCRIPTION	RENK COLOR	ÜRÜN KODU CODE
	<p>Alüminyum ekstrüzyon alt parça SE-100, SE-101 için <i>Aluminium extrusion end slat for SE-100, SE-101</i></p>	<p>Pres <i>Mill finish</i> Beyaz <i>White</i> Gri <i>Grey</i> Kahve <i>Brown</i> Metalik gri <i>Silver metallic</i> Krem <i>Ivory</i> Seçilen RAL <i>Selected RAL</i></p>	<p>ES.444.00.XAP ES.444.01.XAP ES.444.02.XAP ES.444.03.XAP ES.444.04.XAP ES.444.08.XAP ES.444.RA.XAP</p>
	AMBALAJ	standart boylar 6.000, 7.000, 8.000 mm, 5 adetlik paketler halinde	
	PACKAGING	<i>bundles of 5 bars, standard lengths 6.000, 7.000, 8.000 mm</i>	
	<p>Alüminyum ekstrüzyon, kilit kanallı alt parça SL-39, SL-41, SL-45 için <i>Aluminium extrusion end slat, with lock channel for SL-39, SL-41, SL-45</i></p>	<p>Pres <i>Mill finish</i> Beyaz <i>White</i> Gri <i>Grey</i> Kahve <i>Brown</i> Metalik gri <i>Silver metallic</i> Krem <i>Ivory</i> Seçilen RAL <i>Selected RAL</i></p>	<p>ES.441.00.KAP ES.441.01.KAP ES.441.02.KAP ES.441.03.KAP ES.441.04.KAP ES.441.08.KAP ES.441.RA.KAP</p>
	AMBALAJ	standart boy 6.000 mm, 10 adetlik paketler halinde	
	PACKAGING	<i>bundles of 10 bars, standard length 6.000 mm</i>	
	<p>Alüminyum ekstrüzyon, kilit kanallı alt parça SL-39, SL-41, SL-45 için <i>Aluminium extrusion end slat, with lock channel for SL-39, SL-41, SL-45</i></p>	<p>Pres <i>Mill finish</i> Beyaz <i>White</i> Gri <i>Grey</i> Kahve <i>Brown</i> Metalik gri <i>Silver metallic</i> Krem <i>Ivory</i> Seçilen RAL <i>Selected RAL</i></p>	<p>ES.458.00.KAP ES.458.01.KAP ES.458.02.KAP ES.458.03.KAP ES.458.04.KAP ES.458.08.KAP ES.458.RA.KAP</p>
	AMBALAJ	standart boy 6.000 mm, 10 adetlik paketler halinde	
	PACKAGING	<i>bundles of 10 bars, standard length 6.000 mm</i>	

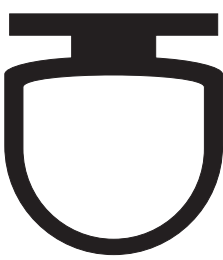
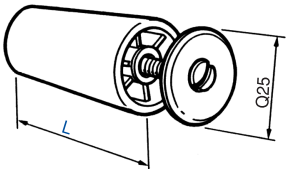
ÜRÜN İTEM	ÜRÜN ÖZELLİKLERİ PRODUCT DESCRIPTION	RENK COLOR	ÜRÜN KODU CODE
	Alüminyum ekstrüzyon, kilit kanallı alt parça SL-55, ST-56, SE-60, SE-62 SE-63 için <i>Aluminium extrusion end slat, with lock channel for SL-55, ST-56, SE-60, SE-62, SE-63</i>	Pres <i>Mill finish</i> Beyaz <i>White</i> Gri <i>Grey</i> Kahve <i>Brown</i> Metalik gri <i>Silver metallic</i> Krem <i>Ivory</i> Seçilen RAL <i>Selected RAL</i>	ES.440.00.KAP ES.440.01.KAP ES.440.02.KAP ES.440.03.KAP ES.440.04.KAP ES.440.08.KAP ES.440.RA.KAP
	AMBALAJ standart boy 6.000 mm, 10 adetlik paketler halinde		
	PACKAGING <i>bundles of 10 bars, standard length 6.000 mm</i>		
	DAP serisi için kauçuk boru fitil ES-427...DAP, ES-441...KAP, ES-458...KAP için <i>Rubber hose insert for DAP series, for ES-427...DAP, ES-441...KAP, ES-458...KAP</i>		ES.DAP.00.INS
	AMBALAJ bir top 100 metre x 2 = 200 m. 1 koli		
	PACKAGING <i>roll of 100 meters x 2 = 200 m. 1 package</i>		
	NAP serisi için kauçuk boru fitil, ES-426...NAP, ES-440...KAP için <i>Rubber hose insert for NAP series, for ES-426...NAP, ES-440...KAP</i>		ES.NAP.00.INS
	AMBALAJ bir top 100 metre x 2 = 200 m. 1 koli		
	PACKAGING <i>roll of 100 meters x 2 = 200 m. 1 package</i>		
	GAP/XAP serileri için kauçuk boru fitil ES-425...GAP, ES-444...GAP için <i>Rubber hose insert for GAP/XAP series for ES-425...GAP, ES-444...GAP</i>		ES.GAP.00.INS
	AMBALAJ bir top 50 metre		
	PACKAGING <i>roll of 50 meters</i>		
	Silindir stopper <i>Cylindrical stopper</i> L=32mm D=25mm	Beyaz <i>White</i> Kahve <i>Brown</i>	SP.040.01.025 SP.040.03.025
	AMBALAJ 200 Adet		
	PACKAGING <i>200 Pieces</i>		